



Data sheet

Fume hood Compact Line DCL-1500 CR



Standard equipment for fume hoods:

- structure entirely made of galvanized steel without the use of wood-based materials
- worktop at a height of 900mm made of monolithic ceramics with a raised rim with a suspended ceramic sink 280x80mm
- toughened glass window, lifted manually with counterweight, opened upwards with a lock at the height of 500 mm (max 810mm), and additionally sliding glass (right / left). The window has a system preventing the uncontrolled drop of the window
- 2 electric sockets 230V 50Hz
- 2 water spouts with valves on the BROEN front panel
- energy-saving linear LED lighting separated from the fume hood with a glass pane
- double system the back wall with exhaust slots in the upper and lower part ensuring proper extraction of vapors lighter or heavier than air without turbulence and dead zones
- safety flap in the ceiling ensuring decompression in the event of uncontrolled pressure increase in the working chamber
- full monitoring set (Schneider brand) air flow velocity in the fume cupboard window compliant with the PE-EN 14175 standard
- CE Declaration of Conformity: PN-EN 14175; PN-EN 14056; PN-EN 13150



TECHNICAL DATA - DIMENSIONS

overall dims [mm]

width A	1580
height B	2325-2600
depth C	960

working space dims (mm)

width D	1450
window width D1	1265
height E	1220
depth F	635

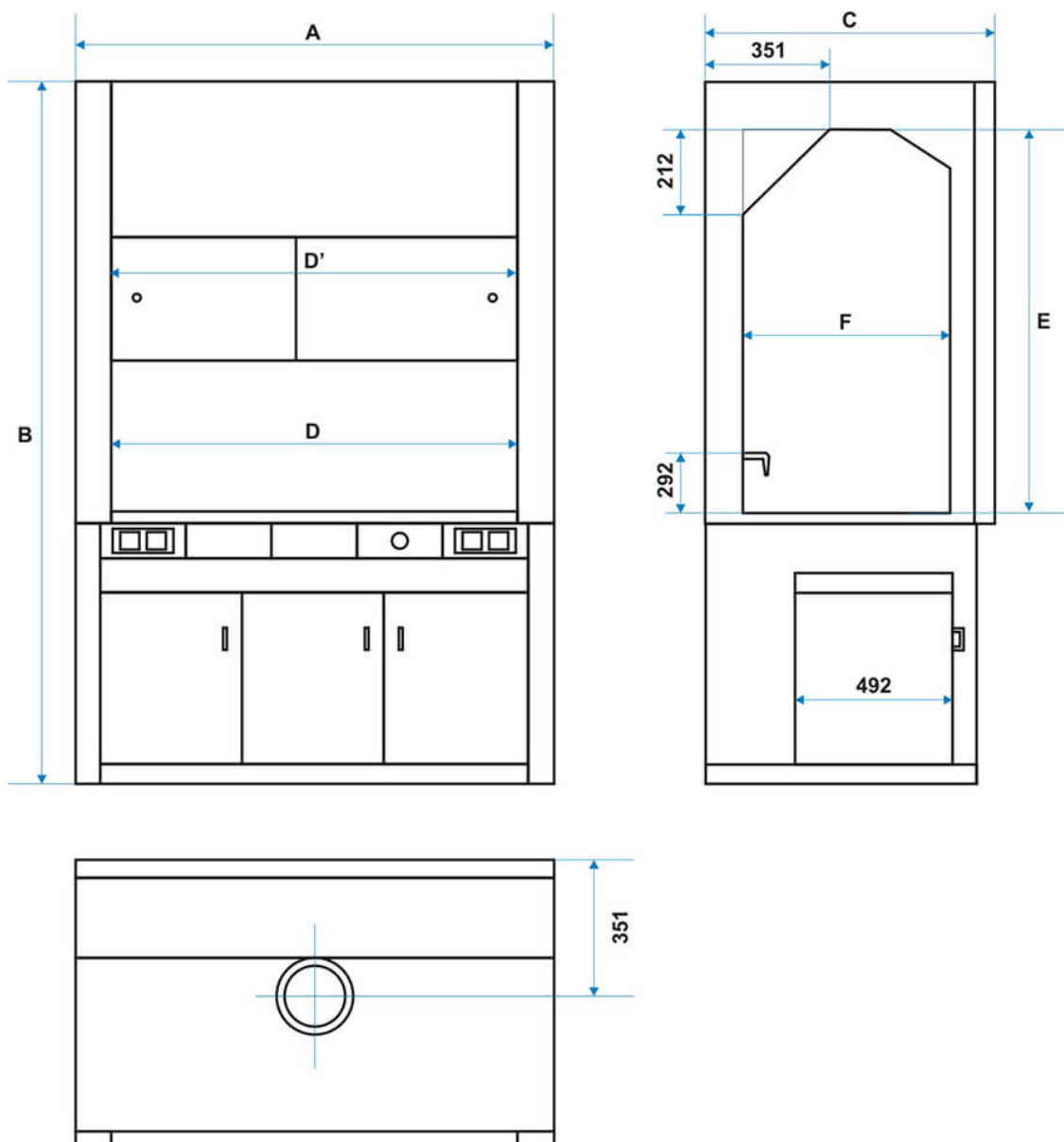



TECHNICAL DATA

recommended airflow [m3/h]	750 - 1200
required capacity of the ventilation system [m/s]	0,3 - 0,5
nominal power [W]	82
voltage**	230 VAC 50Hz
diameter of the air outlet stub [mm]	Ø 200
water supply	G 1/2 " male thread
sewage connection diameter [mm]	Ø 50
electrical insulation	class I
standard ventilation system	double rear wall
illumination installed outside the working chamber	LED, class A ++, through insulating glass / from operator panel
monitoring set	<i>standard:</i> - FM 550-A-0-E controller with a speed sensor AFS 100 in the fume hood window and the FA-0025-3 operator panel <i>option:</i> - ICM 500-F-EU controller with flow control - ICM 500-FP-EU controller with flow control and cooperation with BMS - other Schneider controllers available on request
raising the window	<i>standard:</i> - manual with counterweight (lock at a height of 500mm, maximum opening 810mm) <i>option:</i> - SC 500 - Auto Protect system - with foot switch - SC 500 - Auto Protect system - with panel switch
frame and housing material	The frame is made entirely of galvanized steel. External housing made of galvanized and painted with epoxy paint steel
working chamber wall finishing	Buchtal large-size ceramic
worktop	Monolithic ceramics with marine edge
worktop OPTION (available materials)	- Phenolic resin, epoxy - Stainless steel AISI 304, 316
underbench cabinet OPTION (different types)	- metal, ventilated cabinet painted with epoxy paint - cabinet for acids and alkalis made of foamed PVC - explosion-proof cabinets Asecos 30 and 90 minutes
warranty	24 months
manufacturer	POL-EKO

Other optional equipment:

- main switch
- anti-shock switch
- safety switch
- 400VAC IP44 socket
- additional 230VAC IP44 sockets
- 230VAC sockets inside the working chamber IP44
- Manual Protect system - battery backup of the monitoring set
- power supply control of the socket with the option of timer setting
- additional gas taps
- metal cabinet key lock under the tabletop
- explosion-proof equipment EX
- side glazing
- truss made of acid-resistant steel, on the back wall of the manipulation chamber
- inspection openings
- flexible strip brush